

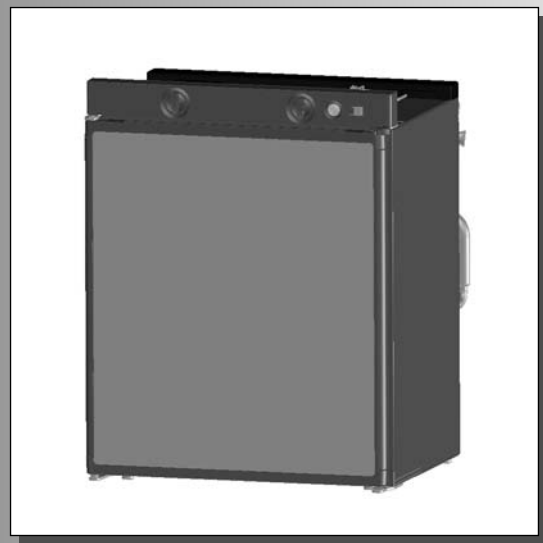

Operating instructions

Absorption refrigerator for recreation vehicles

RM 5310 RM 5330 RM 5380



MBA 11/2011

N 1

Type C40 / 110
821 2690 - 94

Record for future reference:

Model number
Product number
Serial number

AUS / NZ





RM 5310

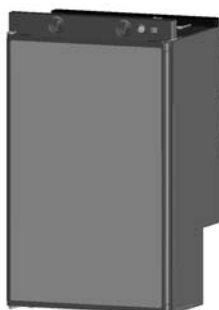

RM 5330



RM 5380

 **Dometic**

Dometic GmbH
In der Steinwiese 16
D-57074 Siegen

www.dometic.com

Table of contents

1.0	General	4
1.1	Introduction	4
1.2	Guide to these operating instructions	4
1.3	Copyright protection	4
1.4	Explanation of symbols used in this manual	4
1.5	Warranty	5
1.6	Limitation of liability	5
1.7	Customer services	5
1.8	Spare parts	5
1.9	Environmental notices	6
2.0	Safety instructions	7
2.1	Application according to regulations	7
2.2	User's responsibility	7
2.3	Protection of children when disposing of the equipment	7
2.4	Working upon and checking the refrigerator	7
2.5	Information on coolant	8
2.6	Operating the refrigerator with gas	8
2.7	Safety instructions when storing foodstuffs	9
3.0	Description of model	10
3.1	Model identification	10
3.2	Refrigerator rating plate	10
3.3	Technical data	11
4.0	Refrigerator operation	12
4.1	Cleaning	12
4.2	Maintenance	12
4.3	Explanation of operating controls	12
4.3.1	Electrical operation	13
4.3.2	Gas operation	13
4.3.3	Setting of cooling compartment temperature	14
4.4	Door locking	14
4.5	Positioning the storage racks	14
4.6	Storing food and making ice cubes	15
4.6.1	Storing products in the cooling compartment	15
4.6.2	Storing products in the freezer compartment	15
4.6.3	Refrigerator compartment	15
4.6.4	Making ice cubes	16
4.7	Defrosting	16
4.8	Shutting off the refrigerator	16
4.9	Exchange of the igniter's battery	17
4.10	Exchange of the interior lighting	17
4.11	Changing the doorhang	17
4.12	Changing the decor panel	18
4.13	Winter operation	18
4.14	Troubleshooting	19

1.0 General

1.1 Introduction

You have made an excellent choice in selecting the **Dometic** Absorption Refrigerator. We are sure that you will be satisfied with your new refrigerator in all respects. The refrigerator, which works silently, meets high quality standards and guarantees the efficient utilisation of resources and energy throughout its entire life cycle, during manufacture, in use and when being disposed of.

1.2 Guide to these operating instructions

Before you start using the refrigerator, please read the operating instructions carefully.

These instructions provide you with the necessary guidance for the proper use of your refrigerator. **Observe in particular the safety instructions.** Observation of the instructions and handling recommendations is important for dealing with the refrigerator safely and for protecting you from injury and the refrigerator from damage. You must understand what you have read before you carry out a task.

Keep these instructions in a safe place close to the refrigerator so they may be referred to at any time.

1.3 Copyright protection

The information, texts and illustrations in these instructions are copyright protected and are subject to industrial property rights. No part of these instructions may be reproduced, copied or utilised in any other way without written authorisation by Dometic GmbH, Siegen.

1.4 Explanation of symbols used in this manual

Warning notices

Warning notices are identified by symbols. A supplementary text gives you an explanation of the degree of danger.

Observe these warning notices rigorously. You will thus protect yourself and other people from injury, and the appliance from damage.



DANGER!

DANGER indicates an imminent hazardous situation which, if not avoided, could result in death or serious injury.



WARNING!

WARNING indicates a potentially hazardous situation which, if not avoided, could result in death or serious injury.



CAUTION!

CAUTION indicates a potentially hazardous situation which, if not avoided, may result in minor or moderate injury.

CAUTION!

CAUTION (used without the safety alert symbol) indicates a potentially hazardous situation which, if not avoided, may result in damage to the appliance.

Information



INFORMATION gives you supplementary and useful guidance when dealing with your refrigerator.

Environmental Tips



ENVIRONMENTAL TIPS gives you useful guidance for saving energy and disposal of the appliance.

1.5 Warranty

Warranty arrangements are in accordance with the normal conditions applicable for the country concerned. For warranty or other maintenance, please contact our customer services department. Any damage due to improper use is not covered by the warranty. The warranty does not cover any modifications to the appliance or the use of **non-original Dometic** parts. The warranty does not apply if the installation and operating instructions are not adhered to and no liability shall be entertained.

1.6 Limitation of liability

All information and guidance in these operating instructions were prepared after taking into consideration the applicable standards and regulations as well as the current state of the art. **Dometic** reserves the right to make changes at any time which are deemed to be in the interest of improving the product and safety.

Dometic will assume no liability for damage in the case of :

- non-observation of the operating instructions
- application not in accordance with the regulations or provisions
- use of non-original spare parts
- modifications and interferences to the appliance
- effect of environmental influences, such as
 - temperature fluctuations
 - humidity

1.7 Customer services

Dometic offers a customer service network. . You can obtain the address information of the nearest customer service from **www.dometic.com**. When contacting Dometic Customer Services, please state the model, product number and serial number together with the MLC code, if applicable. You will find this information on the rating plate inside the refrigerator. We recommend that you note this data in the field provided on the front page of this operation manual.

1.8 Spare parts

Parts can be ordered throughout Australia and New Zealand from our service dealer network.

Always give the model and product number when you contact the customer service! You will find this information on the rating plate inside the refrigerator.

1.9 Environmental notices



Refrigerators manufactured by Dometic GmbH are free of CFC/HCFC and HFC. Ammonia (a natural compound of hydrogen and nitrogen) is used in the cooling unit as a coolant. Non-ozone-hazardous cyclopentane is used as a propellant for manufacturing PU foam insulation.

Disposal

In order to ensure that the recyclable packaging materials are re-used, they should be sent to the customary local collection system. The appliance should be transferred to a suitable waste disposal company that will ensure re-use of the recyclable components and proper disposal of the rest. For eco-friendly draining of the coolant from all absorber refrigeration units, a suitable disposal plant should be used.

Energy-saving tips

- At an average ambient temperature of 25°C, it is sufficient to operate the refrigerator at middle thermostat setting.
- Where possible, always store precooled products.
- Do not expose the refrigerator to direct sunlight.
- Ensure that air circulation of the cooling unit is not obstructed.
- Defrosting at regular intervals saves energy (*see section 4.8 "Defrosting"*).
- Open the refrigerator door only for a short period of time when removing products.
- Run the refrigerator for about 12 hours before filling it.

2.0 Safety instructions

2.1 Application according to regulations

This refrigerator is designed for installation in recreation vehicles such as caravans or motorhomes.

The refrigerator is to be used solely for storing foodstuffs.



WARNING!

The refrigerator is not suitable for the proper storage of medication. Please observe in addition the instructions in the medication package inserts.

2.2 User's responsibility

Anyone operating the refrigerator must be familiar with the safe handling and understand the advice in these operating instructions.

This appliance is not intended for use by persons (including children) with reduced physical, sensory or mental capabilities, or lack of experience and knowledge, unless they are supervised or have been given instruction concerning use of the appliance by a person responsible for their safety. Children should be supervised to ensure that they do not play with the appliance. Cleaning and user maintenance shall not be made by children.

2.3 Protection of children when disposing of the equipment



WARNING!

When disposing of the refrigerator, detach all refrigerator doors and leave the storage racks in the refrigerator. In this way inadvertent entrapment and suffocation is prevented.

2.4 Working upon and checking the refrigerator



WARNING!

Work on gas equipment, exhaust system and electrical facilities must be carried out by authorised personnel only. Substantial damage to property and/or injury to persons can arise through unprofessional procedures.



DANGER!



Never use an unshielded flame to check gas bearing parts and pipes for leakage!

There is a danger of fire or explosion.



WARNING!

Never open the absorber cooling unit! It is under high pressure.

There is a danger of injury!

2.5 Information on coolant

Ammonia is used as a coolant.

This is a natural compound also used in household cleaning agents (1 litre of Salmiak cleaner contains up to 200g of ammonia - about twice as much as is used in the refrigerator). Sodium chromate is used for corrosion protection (1.8% by weight of the solvent).

In the event of leakage (easily identifiable from the strong odour), proceed as follows:

- Switch off the appliance.
- Air the room thoroughly.
- Inform authorised customer services.



For your safety it was ascertained in an expert's report that no impairment of health exists when the coolant is discharged.

2.6 Operating the refrigerator with gas

It is imperative that the operating pressure corresponds to the data specified on the rating plate of the appliance. Compare the operating pressure of the rating plate with the data specified on the pressure reducing valve of the liquid gas cylinder.



WARNING!

Operating the appliance with gas is not permitted

- at petrol stations
- on ferry boats
- while transporting the caravan/motor-home by a transporter or breakdown vehicle.

There is the danger of fire!

Leave the equipment switched off.

2.7 Safety instructions when storing foodstuffs

Instructions for storing food in a refrigerator:

No refrigerator of any kind can improve the quality of the food; refrigerators can only maintain the food's quality for a short duration as from the time of storing it.

Please observe the following particular conditions for storing food in a refrigerator that is built into a vehicle:

- A change in the climatic conditions such as temperature fluctuations
- High temperatures inside the vehicle when it is closed and parked in direct sunlight (temperatures are possible up to 50°C)
- Use of the refrigerator during travel with the power supply of 12V DC
- A refrigerator built in behind a window and exposed to direct sunlight
- Storing the products too soon, i.e. shortly after starting up the appliance for use

Under these particular conditions the refrigerator cannot guarantee reaching the temperature needed for perishables.

Perishables include all products with a stipulated use-by date and a minimum storage temperature of +4°C or less, especially for meat, poultry, fish, sausages, pre-packed foods.

- Pack raw and cooked foods separately (e.g. in containers, aluminium foil, etc.).
- Only remove the outside packaging of single packs if all the necessary information, e.g. the use-by date, can also be read on the single packs.
- Do not leave cooled goods outside the refrigerator for too long.
- Place the foods with the next use-by date at the front, accordingly.
- Pack away any left-over food and eat at the first opportunity.
- Wash your hands before and after handling any food.

- Regularly clean the inside of the refrigerator.

Please observe the instructions and information regarding the use-by date on the outside packaging of the food.

Please observe section "4.1 Cleaning" of this instruction.

3.0 Description of model

3.1 Model identification

Example :



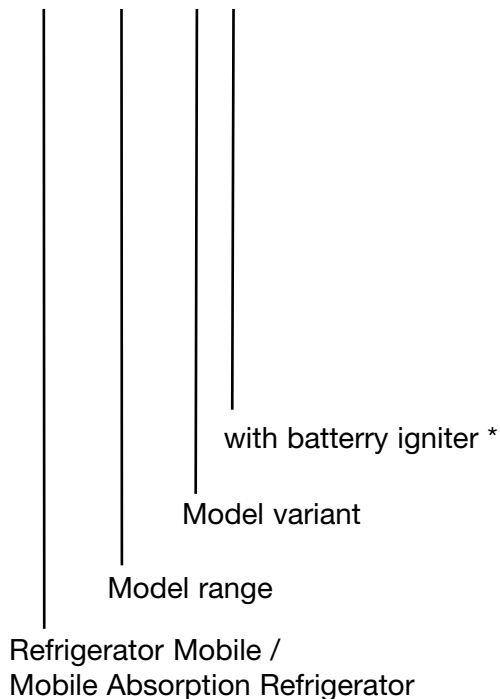



RM 5310



* = manual ignition with **battery igniter**

3.2 Refrigerator rating plate

The rating plate is to be found on the inside of the refrigerator. It contains all important details of the refrigerator. You can read off from this the model identification, the product number and the serial number. You will need these details whenever you contact the customer service centre or when ordering spare parts.

Dometic			
TYPE	C 40/110	CLIMATE CLASS	SN SAFETY CLASS T
MOD. NO.	RM 5310 1	PROD. NO.	00999002909 2 C 00 SER. NO. 12399999 3
BRUTTOINHALT TOTAL CAP. VOLUME BRUT	60 l	VERDAMPFERFACH FREEZER COMP. VOLUME COMPT BT	5 l
		NUTZINHALT USEFUL CAP. VOLUME NET	55 l
~ 230-240V / 125 W --- 12 V / 120 W	PROPANE	NGC: 0.82	MJ/h
4	5	INLET: 2,75 kPa TPP: 2,69 kPa INJECTOR: 43	
CE 0063 BL3214	G30, G31	p = 30/37 mbar	
ABSORBER	NH ₃ = 115 g	Na ₂ CrO ₄ = 7,0 g	p max = 35 bar
    			APPROVAL NO. A/10239EA ACN 004 947 488 A.G.A. 3437
MADE IN GERMANY		00085394887	

Example

Fig. 1

- 1** Model number
- 2** Product number
- 3** Serial number
- 4** Electrical rating details
- 5** Gas pressure

3.3 Technical data

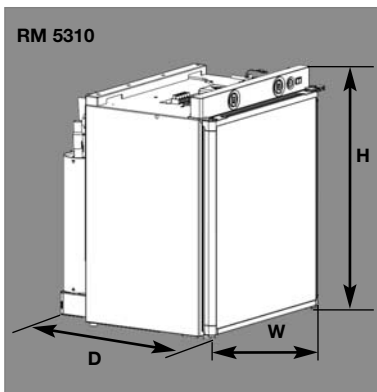

Fig. 2

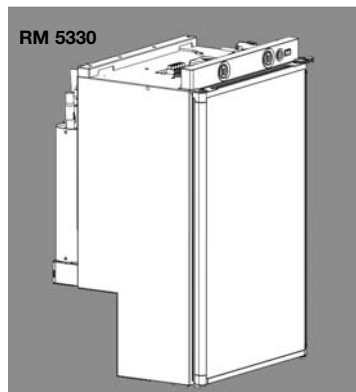

Fig. 3

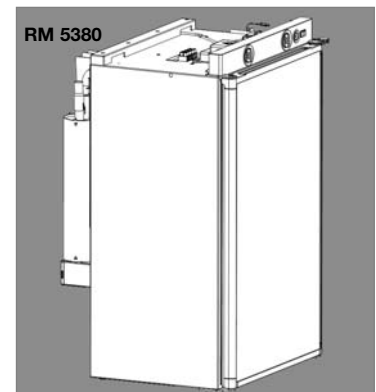

Fig. 4

Model	Dimensions H x W x D (mm) Depth incl. door	Gross capacity		Rating details mains/battery	Consumption * electricity/gas over 24hrs	Net weight	Ignition	
			freezer compartment				manual	automat.
RM 5310	618x486x474	60 lit.	5 lit.	125 W / 120 W	ca.2,5 kWh / 270 g	20 kg	•	
RM 5330	821x486x474	70 lit.	5 lit.	125 W / 120 W	ca.2,5 kWh / 270 g	22 kg	•	
RM 5380	821x486x474	80 lit.	5 lit.	125 W / 120 W	ca.2,5 kWh / 270 g	24 kg	•	

Subject to technical changes.

*Average consumption measured at an average ambient temperature of 25°C in pursuance of ISO Standard.

4.0 Refrigerator operation



The refrigerator is equipped to operate on three power modes:

- Mains voltage (230V AC)
- Direct-current voltage (12V DC)
- Gas (liquid gas propane/butane)

Each refrigerator with manual ignition is equipped with an automatic flame safety valve which interrupts the gas supply automatically after approx. 30 seconds when the flame has extinguished.

4.1 Cleaning

Before starting up the refrigerator, it is recommended that you clean it inside and repeat this at regular intervals.

Use a soft cloth and lukewarm water with a mild detergent. Then wipe out the appliance with clean water and dry thoroughly.

To avoid material alterations, do not use soap or hard, abrasive or soda-based cleaning agents. Do not allow the door seal to come into contact with oil or grease.

4.2 Maintenance

- **The gas burner must be inspected and cleaned as necessary at least once a year. When using liquefied petroleum gas (tank or refill cylinders) the maintenance interval is reduced to half-yearly or quarterly.**

Keep the evidence of maintenance work carried out on your refrigerator.

- **Work on gas and electrical equipment shall be carried out by qualified personnel only.**

It is recommended that this is carried out by an authorised customer services department.

We recommend maintenance following an extended shutdown of the vehicle. Please contact our customer services.

4.3 Explanation of operating controls

Manual energy selection / manual ignition with battery igniter

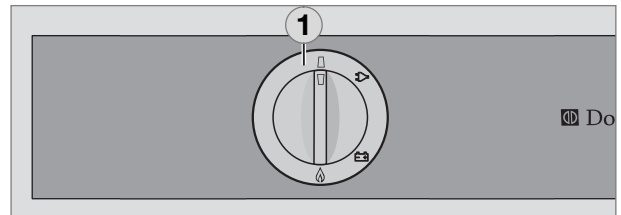

Fig. 5

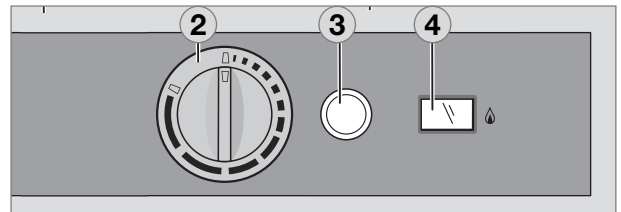

Fig. 6

- ① = Power On switch / Energy selector switch
- ② = Temperature controller
- ③ = Battery igniter (gas)
- ④ = Flame indicator (galvanometer)

Explanations:

The refrigerator is equipped to operate on mains power, 12V DC or liquid gas. Select the desired power supply by turning the **energy selector switch (1)**. The energy selector switch (1) has four settings:

- Off
- Mains voltage (230V AC)
- Direct-current voltage (Batterie, 12V DC)
- Gas (liquid gas propane/butane)

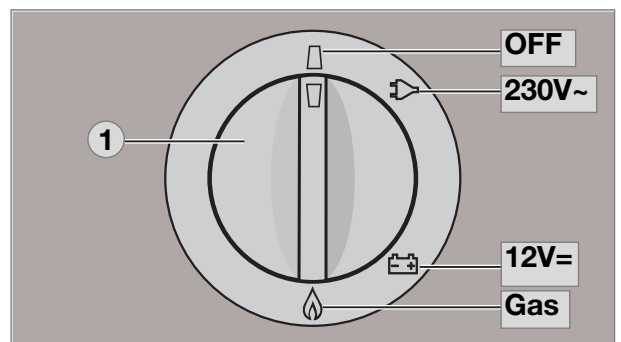
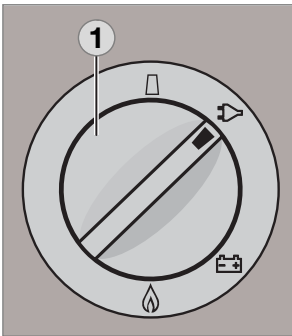

Fig. 7

4.3.1 Electrical operation



230 V

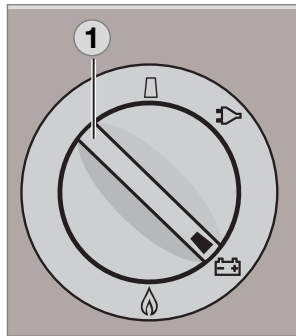
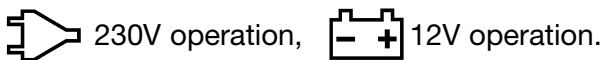

Fig. 8 12 V

Fig. 9

Switch on the appliance by turning the energy selection switch **(1)** clockwise to position :



CAUTION !

The refrigerator should only be used in 12VDC-operation while the vehicle's engine is running, otherwise the on-board-battery would be discharged within a few hours!

4.3.2 Gas operation (liquid gas)

Appliances with battery igniter

- The refrigerator must be operated using liquid gas (**propane, butane**) (**no natural gas or town gas**). When using LPG gas, please consider that the burner needs cleaning at shorter intervals due to the gas combustion method (2 - 3 times per year recommended).
- In Europe, gas operation is permitted while travelling only on the condition that the gas system of the vehicle is equipped with a hose rupture protection. The national regulations of the respective country must be observed.
- For physical reasons, gas ignition faults could occur starting from an altitude above sea level of approx. 3280 ft. / 1000 m (**No malfunction!**)

- On the initial refrigerator start-up or after a cylinder change, air may be trapped in the gas line. To purge the air from the lines, switch on the refrigerator and any other gas appliances (e.g. stove) for a short time. The gas ignites without delay.

WARNING!

As a basic rule, gas operation is prohibited in petrol stations

Prior to starting the refrigerator in gas mode :

- Open the gas cylinder valve.
- Open the shut-off valve for gas supply to the refrigerator.

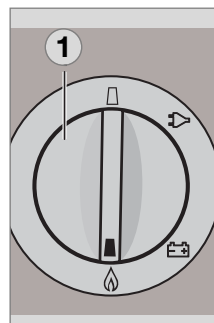

Fig. 10

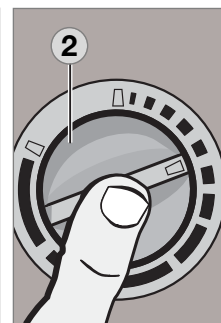

Fig. 11

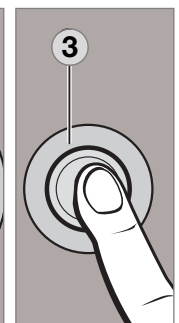

Fig. 12

1. Turn the rotary selector switch **(1)** to position .
2. Turn the temperature selector **(2)** clockwise and push. Keep the controller button depressed.
3. Then, press knob **(3)** of battery igniter down and keep it depressed. The ignition process is activated automatically.
4. Once the flame ignites, the pointer of galvanometer **(4)**(p. 13) begins moving into the green range. The refrigerator is operational. Keep knob **(2)** depressed for approx. 15 seconds and finally release it.

4.3.3 Setting of cooling compartment temperature

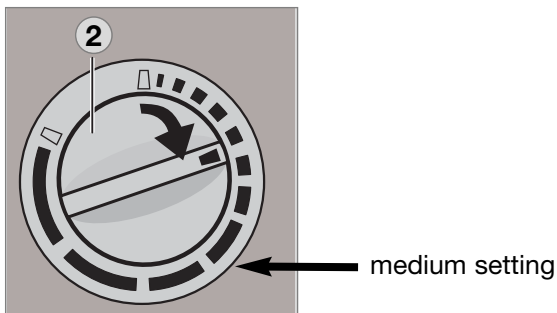

Fig. 13

Select the desired cooling compartment temperature by turning the rotary knob (2).

The scale starts with **MIN** position (small bar = highest temperature) and climbs up to **MAX** position (large bar = lowest temperature).

Note: The temperature levels do not relate to absolute temperature values.

12V: The refrigerator operates without thermostat control (continuous operation).



The cooling unit's performance is influenced by ambient temperatures. Please select the medium setting for ambient temperatures between +15°C and +25°C (refer to Fig. 28, temperature level 3). The unit operates within its optimum performance range.

Dometic refrigerators work according to the absorption principle. For physical reasons, an absorption system responds slowly to changes made by the thermostat controller, by loss of cooling energy through opening the door or during storing food. The devices meet the cooling performance requirements of the Climatic Class SN acc. to EN/ISO 7371 in the temperature range of +10°C to +32°C ambient temperature.

For ambient temperatures exceeding +32°C for a longer period of time, it is recommended installing Dometic additional fan.

4.4 Door lock



CAUTION!

As a basic rule, shut and lock the refrigerator before you start your journey!

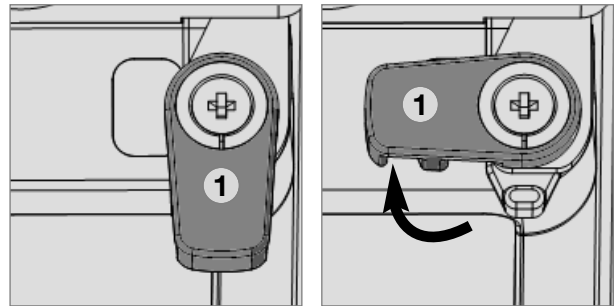

closed

Fig. 14

open

Fig. 15

To open the door turn the travel catch (1) sideways and pull the door (s. fig. 15).

4.5 Positioning the storage racks

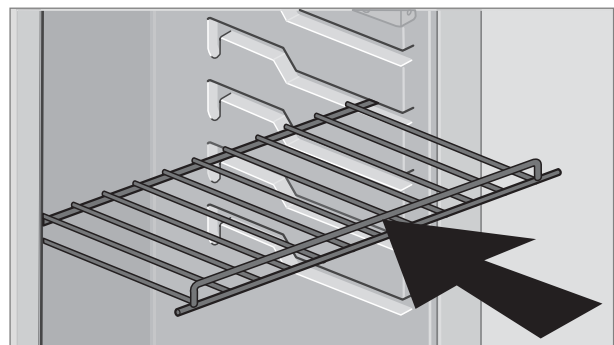

Fig. 16

The storage racks may be pulled out by smoothly lifting them and may be positioned as desired.

4.6 Storing food and making ice cubes

4.6.1 Storing products in the cooling compartment

- Switch the refrigerator on approx. 12 hours before filling it.
- Always store pre-cooled foods in the refrigerator. Make sure that the food is well cooled when it is bought and also when transporting it. Use insulated cooling bags.
- Open the refrigerator door only for a short period of time when removing products.
- Products must be packed - best of all in closed containers, wrapped in aluminium foil or similar - and stored separately from each other, in order to prevent drying out or odours.
- Allow foods that have been warmed up to cool down before storing.
- Avoid storing products in the refrigerator that could emit volatile flammable gases.
- Do not overfill the storage grids and compartments to prevent obstructing the internal air circulation.
- Maintain a clearance of approx. 5 - 10 mm between chilled products and post-evaporator ("cooling fins").
- Do not expose the refrigerator to direct sunlight. Please bear in mind that the temperature inside a closed vehicle increases sharply if exposed to sunlight and that this can reduce the efficiency of the refrigerator.
- Ensure that air circulation of the cooling unit is not obstructed. Keep the ventilation grilles free from obstructions.

4.6.2 Storing products in the freezer compartment

- Do not keep carbonated drinks in the freezer.
- The freezer compartment is suitable for making ice cubes and for short-term storage of frozen food. It is not suitable as a means of freezing foods.

When ambient temperatures are lower than +10°C and the refrigerator is exposed to these temperatures for extended periods of time, an even regulation of freezer temperature cannot be guaranteed for system-related reasons. This can cause the temperature in the freezer to rise and the stored goods to melt.

4.6.3 Refrigerator compartments

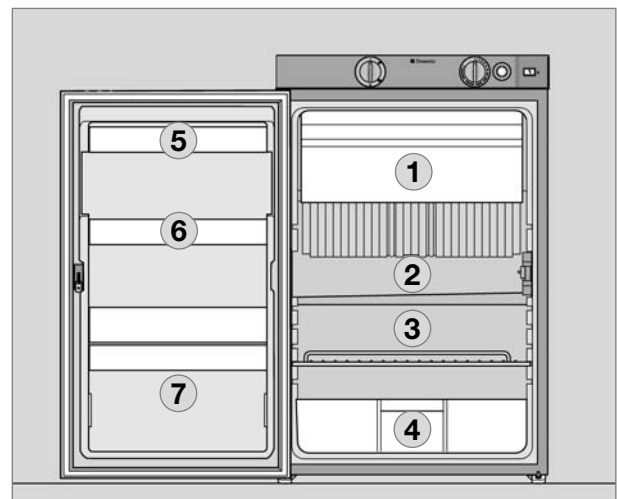

Fig. 37

- ① **Freezer compartment :**
already frozen food (deep-frozen food)
- ② **Middle compartment:**
Dairy products, convenience food
- ③ **Bottom compartment:**
Meat, fish, food for defrosting
- ④ **Vegetable compartment:**
Salads, vegetables, fruit
- ⑤ **Top door shelf:**
Eggs, butter
- ⑥ **Middle door shelf:**
Cans, dressings, ketchup, jam
- ⑦ **Bottom door shelf (drinks compartment):**
Drinks in bottles or bags

4.6.4 Making ice cubes

Ice cubes are best frozen overnight. At night, the refrigerator has less work to do and the unit has more reserves.

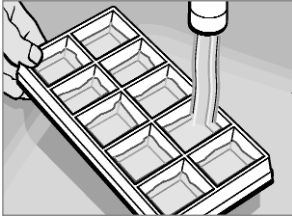

Fig. 17

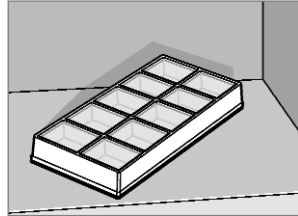

Fig. 18

1. Fill the ice cube tray with drinking water.
2. Place the ice cube tray in the freezer compartment.



WARNING!

Only use drinking water!

4.7 Defrosting

As time goes by, frost builds up on the fins inside the refrigerator. A layer of frost thicker on one side may occur and does not represent a malfunction. When this layer of frost is about 3 mm thick, the refrigerator should be defrosted.

- Switch off the refrigerator, as described in section 4.8 *Shutting off the refrigerator*.
- Remove all food and the ice cube tray.
- Leave the refrigerator door open to allow air to enter and to prevent formation of mildew.
- After defrosting (freezer compartment and fins free of frost), wipe both cooling compartments dry with a cloth.

Note: Water thawing in the main compartment of the refrigerator runs into an appropriate container at the back of the refrigerator. From there, the water evaporates.

CAUTION!

The layer of ice must never be removed forcibly, nor may defrosting be accelerated using a heat source!

4.8 Shutting off the refrigerator

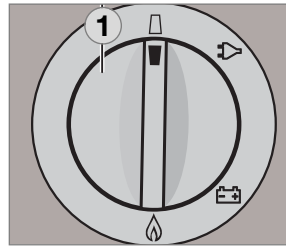

Fig. 19

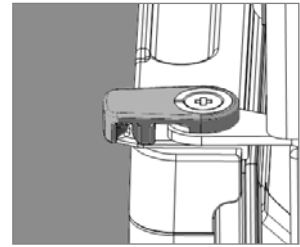

Fig. 20

- Set the energy selector switch (1) to position "OFF". The appliance is switched off.
- Secure the door open by means of the door stop. The door will be slightly ajar. This is to prevent mould from forming inside the appliance.
- If the refrigerator is to be taken out of service for an extended period of time, close the on-board shut-off valve and the cylinder valve.

4.9 Exchanging the igniter's battery

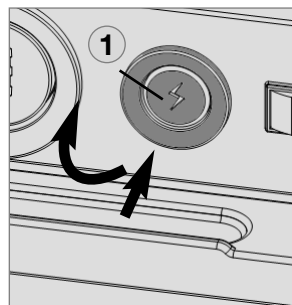

Fig. 27

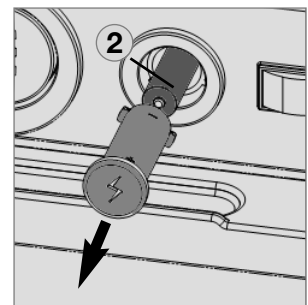

Fig. 28

Unlock the battery (2) by depressing and turning the button (1) approx. 90° clockwise (by means of a suitable screw driver). After removing the cap, the battery (1.5 V AAA/R3/Micro) can be removed and replaced.

Observe correct polarity!

4.10 Exchange of interior lighting

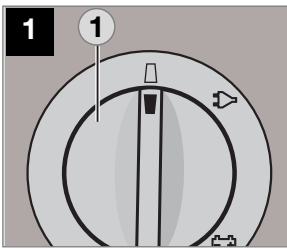

Fig. 21

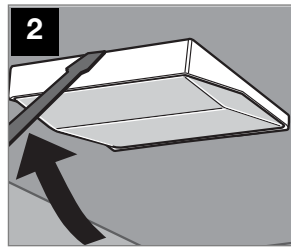

Fig. 22

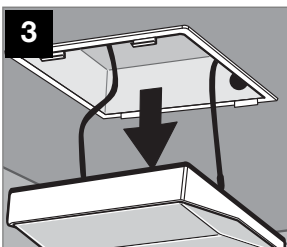

Fig. 23

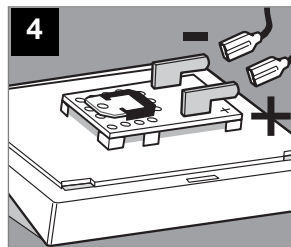

Fig. 24

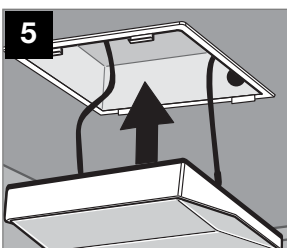

Fig. 25

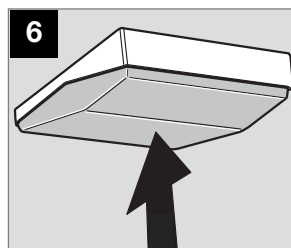

Fig. 26

Please contact Dometic Service Centres for replacement LED-lighting.

- Switch off the refrigerator.
- Remove the reflector disk.
- Loosen LED-housing and take it off.
- Connect new LED-board. Observe polarity.
- Clip the LED-housing back in place.
- Clip reflector disk back in.
- Switch on the refrigerator.

4.11 Changing the doorhang

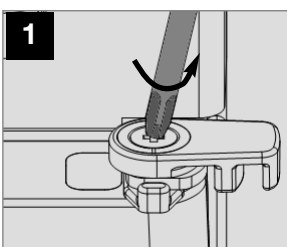

Fig. 29

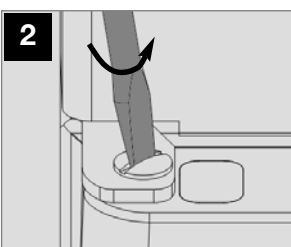

Fig. 30

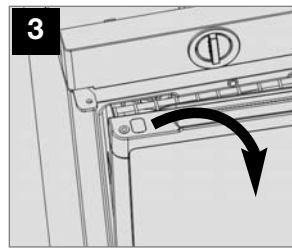

Fig. 31

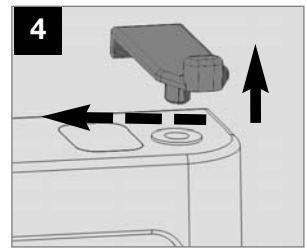

Fig. 32

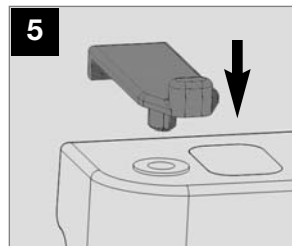

Fig. 33

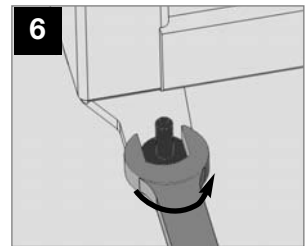

Fig. 34

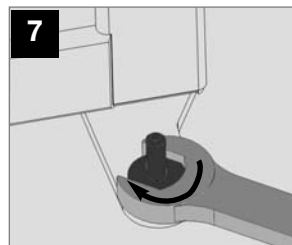

Fig. 35

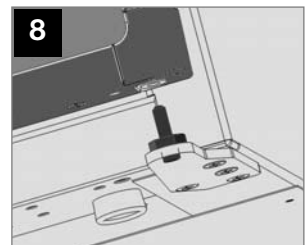

Fig. 36

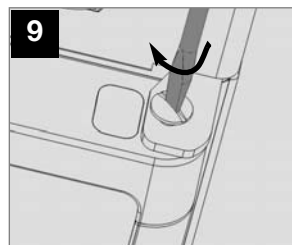

Fig. 37

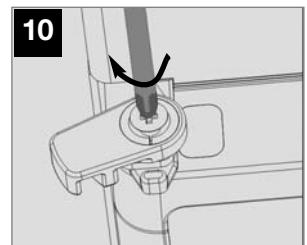

Fig. 38

- Unscrew the travel catch (door lock)
- Remove screw, travel catch and distance ring.
- Unscrew the hinge screw at the opposite side and keep it to hand.
- Lift the door from for removing it.
- Remove the travel catch nose from the door and mount it on the opposite side.
- Unscrew the lower hinge pin and mount it on the opposite side hinge .
- Fit the door on the hinge pin.
- Screw on the upper hinge screw.
- Screw on the travel catch.

4.12 Changing the decor panel

- Remove the door, see "4.11 Changing the doorhang".

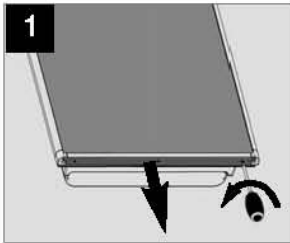

Fig. 39

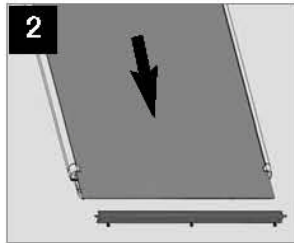

Fig. 40

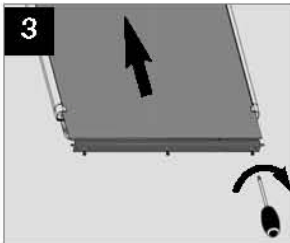

Fig. 41

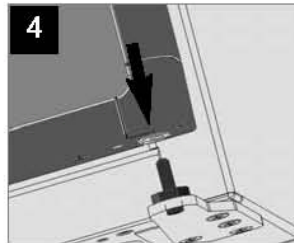

Fig. 42

- Loosen three screws of the lower moulding and remove trim moulding.
- Withdraw the decor panel by sliding it downwards. Fit new panel and slide it upwards as far as possible.
- Fit the trim moulding back in place.
- Fit the door on the hinge pin.

Decor panel dimensions :

Model RM 5310

Height	Width	Thickness
532 +/-1 mm	453 +/-1 mm	max. 3,8 mm

Model RM 5330

Height	Width	Thickness
740 mm	453,5 mm	max. 3,8 mm

Model RM 5380

Height	Width	Thickness
740 mm	453,5 mm	max. 3,8 mm

4.13 Winter operation

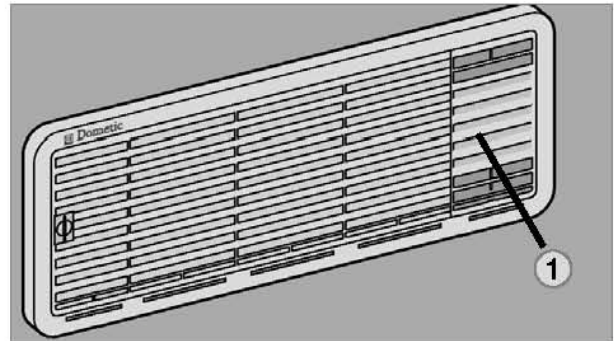

Fig. 43

4.14 Troubleshooting

Before notifying the authorised Service Center, please check whether:

- the instructions in section "Operating the refrigerator" have been observed.
- the refrigerator stands level.
- it is possible to operate the refrigerator with any available power source.

Failure: The refrigerator does not cool sufficiently.

Possible cause	Action you can take
<ul style="list-style-type: none"> ■ Inadequate ventilation to the unit. ■ Thermostat setting is too low. ■ The condenser is heavily frosted. ■ Too much warm food has been stored inside within short period of time. ■ The appliance has been running for only a short period of time. ■ Ambient temperatures too high. 	<ul style="list-style-type: none"> ■ Check that the ventilation grilles are not covered. ■ Set thermostat to a higher level. ■ Check that the refrigerator door closes properly. ■ Allow warm food to cool down before storage. ■ Check whether the cooling compartment works after approx. 4 - 5 hours. ■ Regularly remove ventilation grilles.

Failure: The refrigerator does not cool in gas operation mode.

Possible cause	Action you can take
<ul style="list-style-type: none"> ■ Gas cylinder empty. ■ Upstream shut-off device closed. ■ Air in the gas pipe. 	<ul style="list-style-type: none"> ■ Change gas cylinder. ■ Open shut-off device. ■ Switch off the appliance and start again. Repeat this procedure 3 - 4 times, if necessary.

Failure: The refrigerator does not cool in 12V operation.

Possible cause	Action you can take
<ul style="list-style-type: none"> ■ On-board fuse defective. ■ On-board battery discharged. ■ Engine not running. ■ Heating element defective. 	<ul style="list-style-type: none"> ■ Fit new fuse. ■ Check battery, charge it. ■ Start engine. ■ Please inform the Dometic Customer Services.

Failure: The refrigerator does not cool in 230V operation.

Possible cause	Action you can take
<ul style="list-style-type: none"> ■ On-board fuse defective. ■ Vehicle not connected to mains supply voltage. ■ Heating element defective. 	<ul style="list-style-type: none"> ■ Fit new fuse. ■ Make a connection to a mains power supply. ■ Please inform the Dometic Customer Services.

